



Sammie Bunk Instructions



furnituretree

Free phone: 0800 22 22 10
www.furnituretree.co.nz



Step 1.
Open up hardware pack, group the same parts together.



Step 2.
There are a lot of pieces so be sure you have everything you need before you start assembling. Keep them tidy.



Step 3.
Firmly but, gently, hammer the dowels all the way into the end of the rails.



Step 4.
Place dowel into holes and the M6 x100mm through the bunk ends and place barrel nut in the holes in the rail. Bring together and hand tighten. Do this on all four corners on both the top and the bottom bunk.

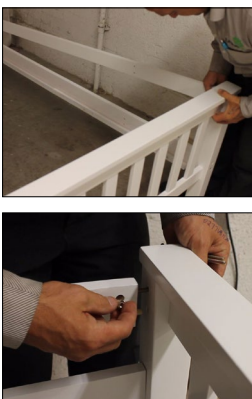

Step 5.
Repeat this process with the safty rails. Do not over tighten.



Step 6.
The bunk can be attached with the ladder either end. Decide what end suits and fasten with the M6 x35mm to upright rails.



Step 7.
Fit all the safty rails with Uprights using your M6 x35mm.



Step 8.
Go through and tighten all joinings with your allen key. Do not over tighten.



Step 9.
You should now have two beds that look like this.



Step 10.
Place the slats on bunks pull them out to the stops so that they are taut. Screw them into place firmly but, do not over tighten. If you over tighten the screws will rip out of the timber.

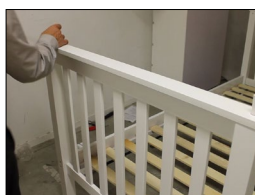

Step 11.
Place wood pin in holes on top of the bottom bunk. Place top bunk on top. You will need another person for this.

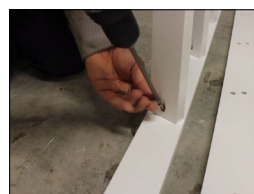

Step 12.
Fit ladder steps to ladder rails with the screw holes facing down. Make sure the dowels are as far into the ladder rails as possible. Screw together using pilot holes.



Step 13.
Repeat this process on the other side to complete the ladder.



Step 14.
And finally place the ladder on the bed side rail and screw into place

To find video instructions go here:

<http://furnituretree.co.nz/index.php/help-faq>

SAMMIE BUNK 2 BED SLAT

IMPORTANT - READ CAREFULLY - RETAIN FOR FUTURE REFERENCE

- All assembly fastenings should always be tighten properly and care should be taken that no fittings are loose
- This bunk bed should not be used if any structural part is broken or missing
- Upper bed of bunk beds are not suitable for children under six years due to the risk of injury from falls
- Children can strangle in items such as ropes, strings, cords, harnesses and belts attached to or hung on a bunk bed
- This bed is suitable for mattress with the size of (WxL):900 X 1900mm (Thickness of mattress should not above this max. mattress height as indicated here)

Warning : " Children can become trapped between the bed and the wall. To avoid risk of serious injury the distance between the top safety barrier and the wall shall not exceed 75mm or shall be more than 230mm"

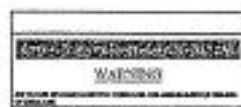



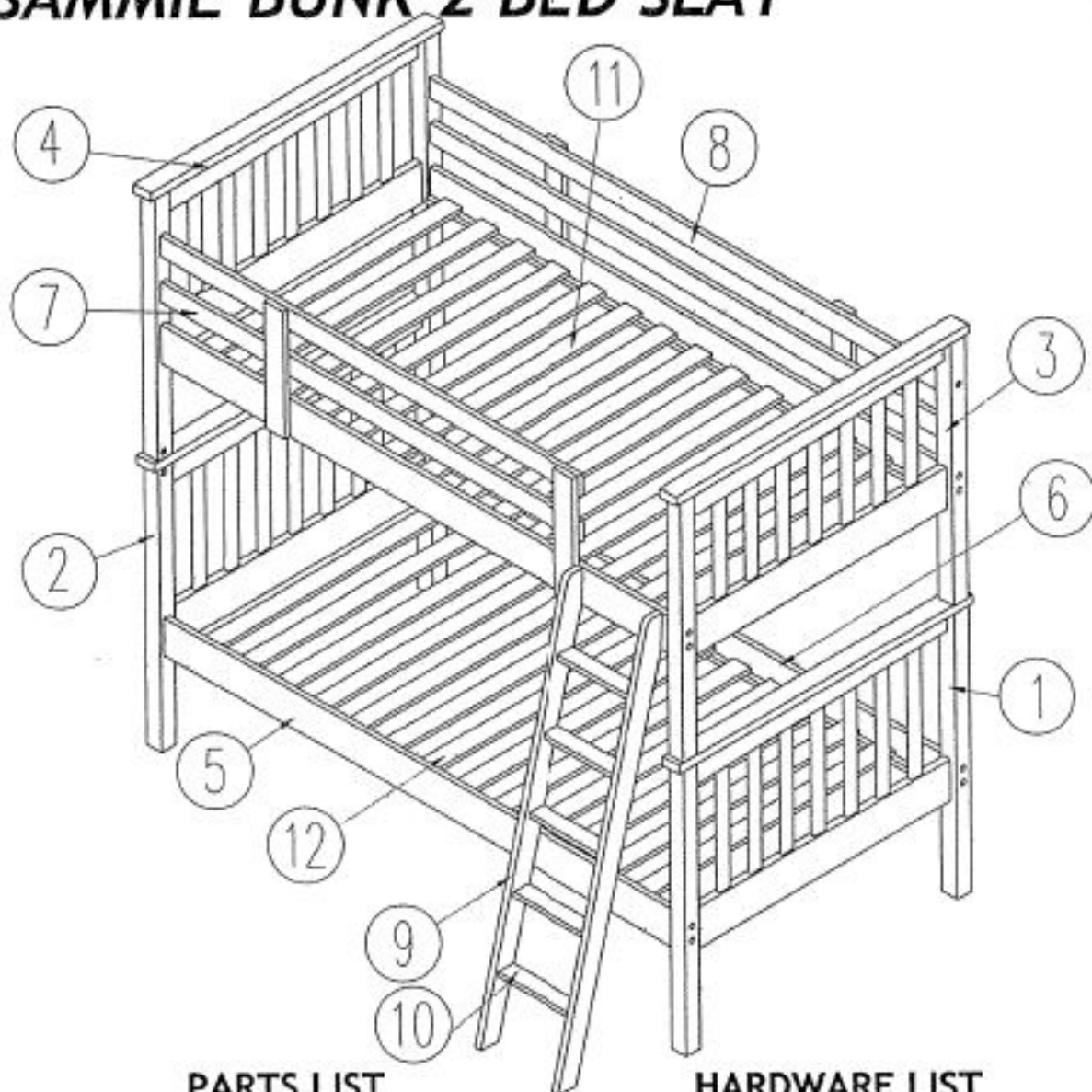





SAMMIE BUNK 2 BED SLAT



PARTS LIST

NO	DESCRIPTION	QTY
1	Lower Footboard	1 pc
2	Lower Headboard	1 pc
3	Upper Footboard	1 pc
4	Upper Headboard	1 pc
5	Lower Bed Side Rail (Front)	1 pc
6	Lower Bed Side Rail (Back)	1 pc
7	Upper Bed Safety Barrier (Front)	1 pc
8	Upper Bed Safety Barrier (Back)	1 pc
9	Lodder (L/R)	2 pcs
10	Lodder Step	5 pcs
11	Upper Bed Slat	1 set
12	Lower Bed Slat	1 set

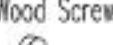
HARDWARE LIST

NO	DESCRIPTION	QTY
A	M6 x100mm JCBC 	19 pcs
B	Barrel Nut 	19 pcs
C	M6 x 35mm JCBC 	24 pcs
D	JCN Nut 	8 pcs
E	Ø8 x 40mm Wood Dowel 	17 pcs
F	Ø10 x 40mm Wood Dowel 	20 pcs
G	M4 x 32mm Wood Screw 	34 pcs
H	Wood Pin 100mm 	4 pcs
I	Allen Key 	1 pc
J	M3.5x16 mm Wood Screw 	2 pcs
K	Wood Button 	12 pcs

SAMMIE BUNK 2 BED SLAT

Kindly follow assembly instruction step by step.

STEP 1

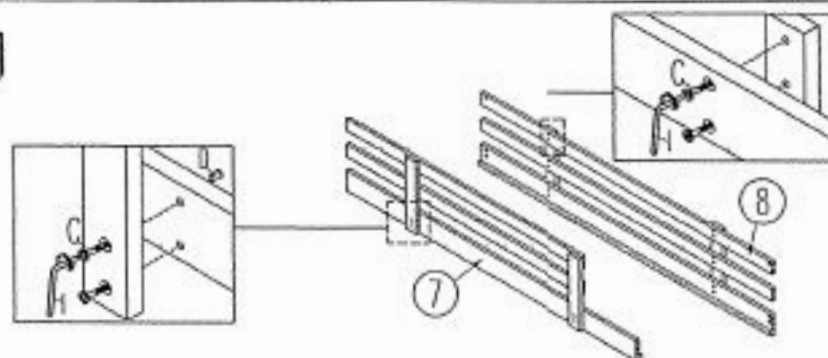

STEP 2

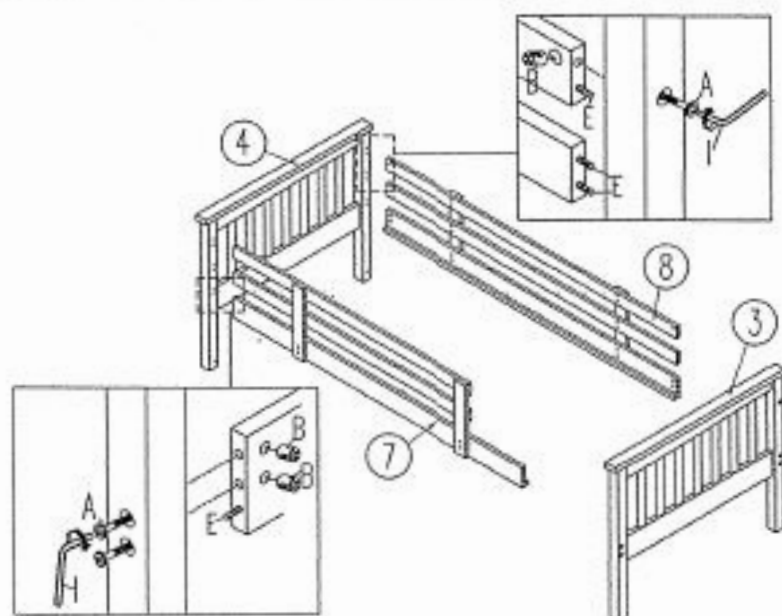

STEP 3



SAMMIE BUNK 2 BED SLAT

Kindly follow assembly instruction step by step.

STEP 4

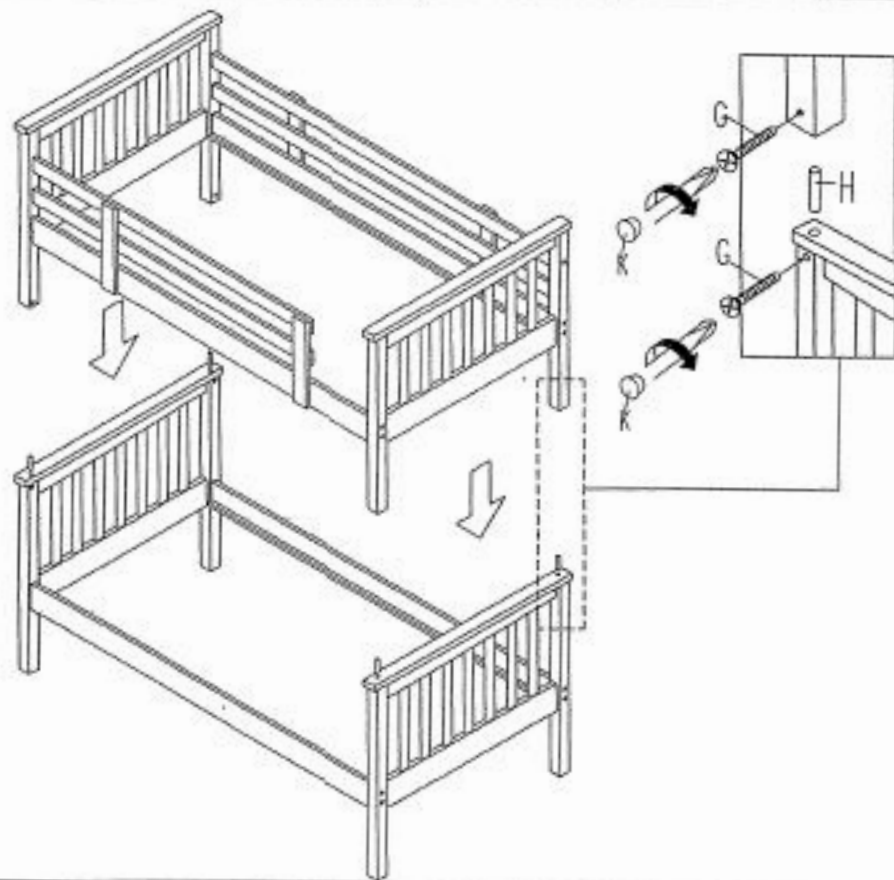

STEP 5

